

Blätterrauschen

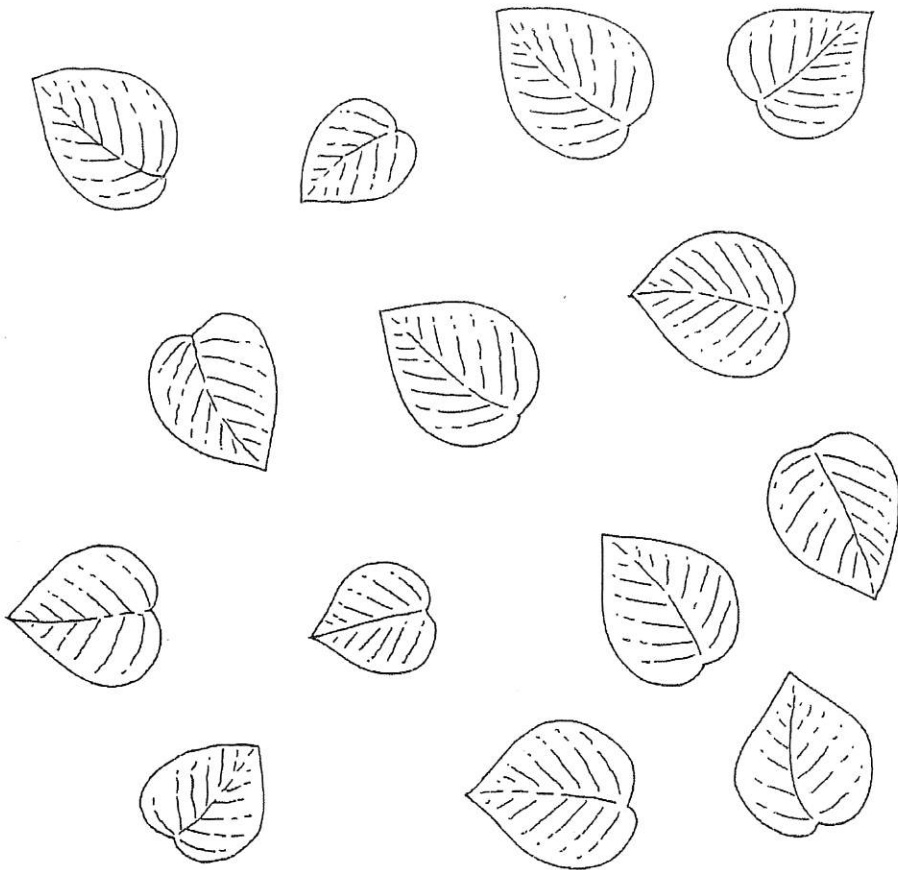

Male die Blätter an.

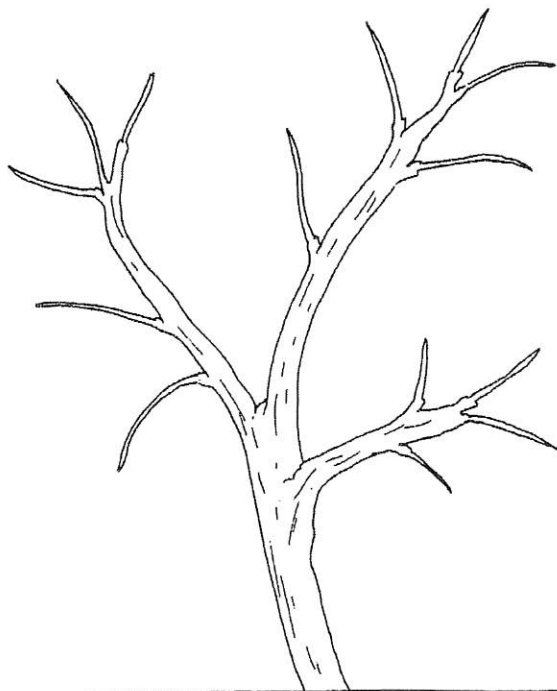

Schneide sie aus.



Klebe sie an die Stiele am Ast.



Bunte Blumen blühen

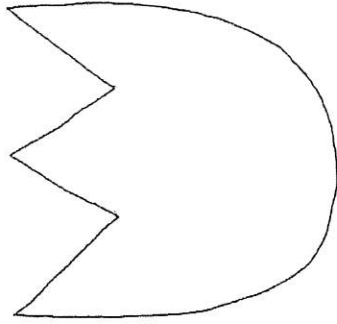
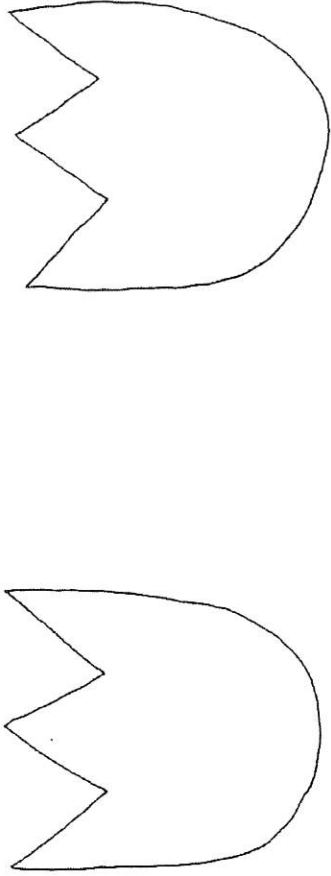

Male die Blüten an.



Schneide sie aus.



Klebe sie an die Stiele.



Häschen auf der Wiese...

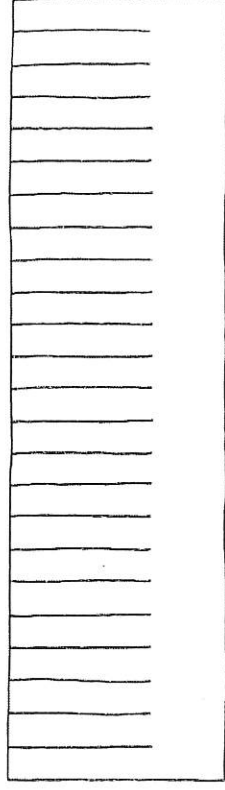
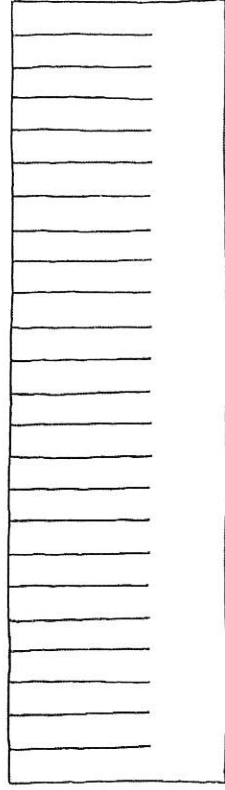
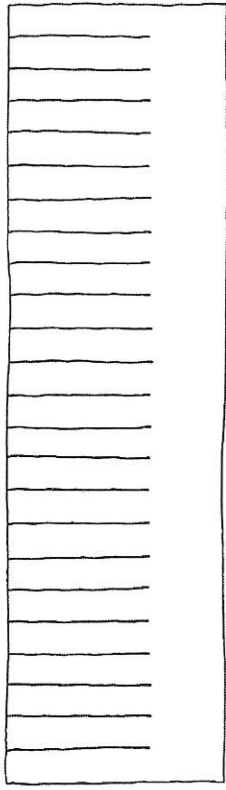
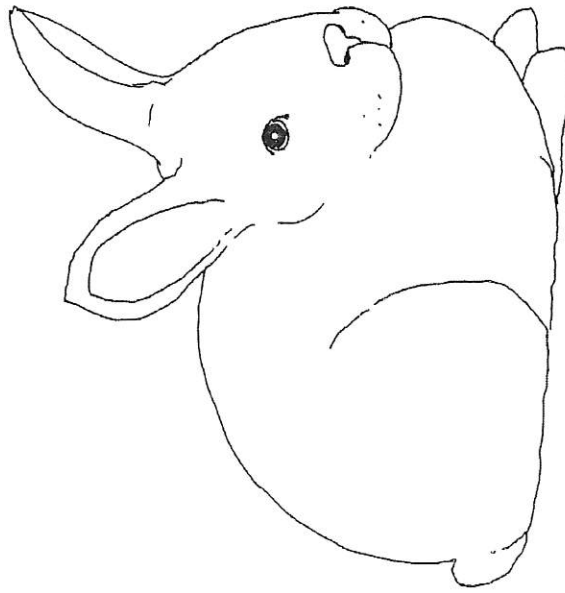

Male die Grassstreifen an.



Schneide die Streifen aus und die Linien ein.



Klebe die Streifen der Reihe nach auf die gepunkteten Flächen.



Was zieht der Junge an?

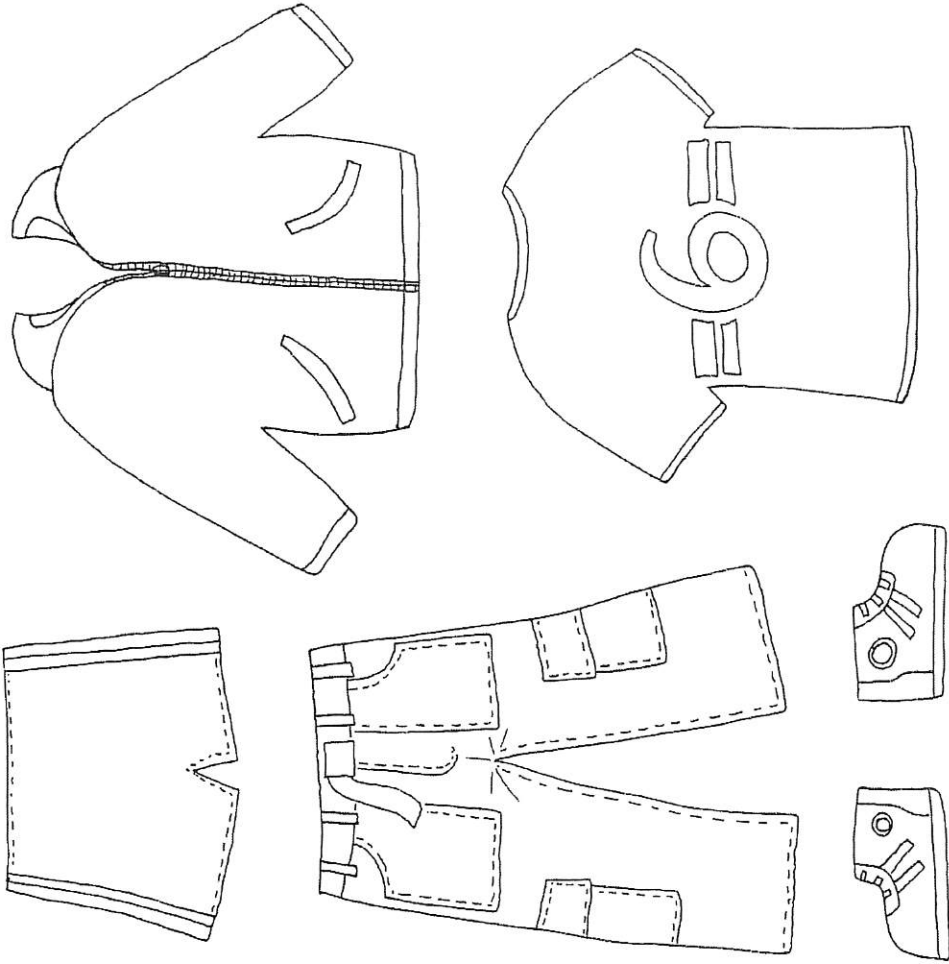
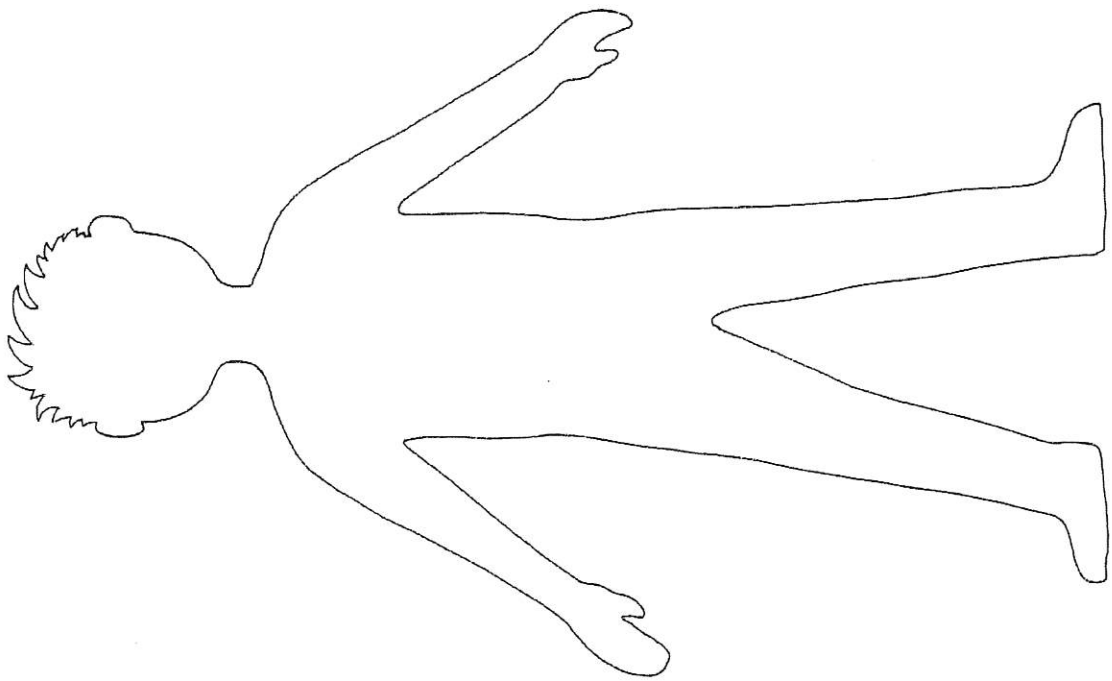

Male die Kleidung an.



Schneide die Teile aus.

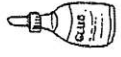

Klebe sie auf den Jungen.



Der Kranwagen

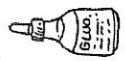
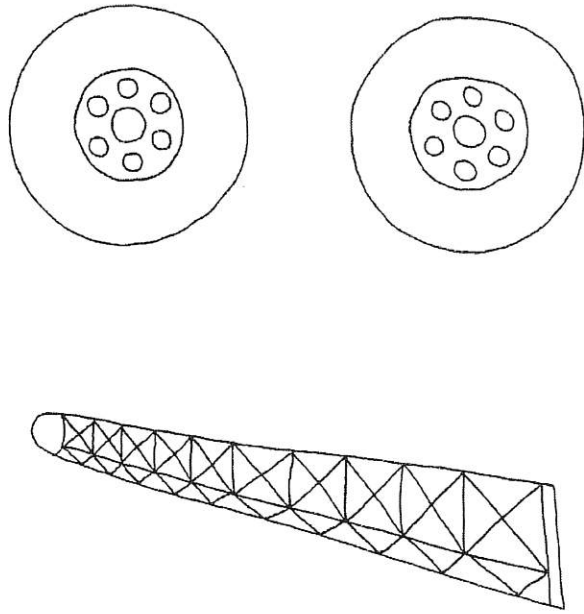
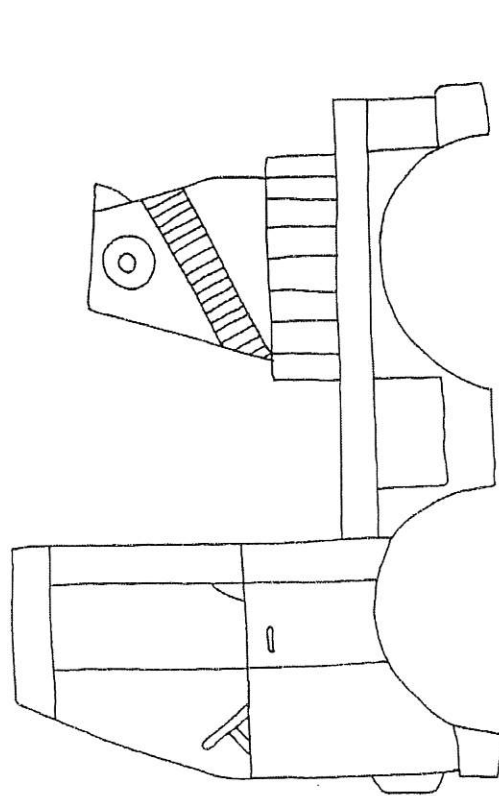

Male den Kranwagen und die Teile an.

Schneide die Teile aus.

Klebe die Teile an den Kranwagen.



Hmm, mein Lieblingseis

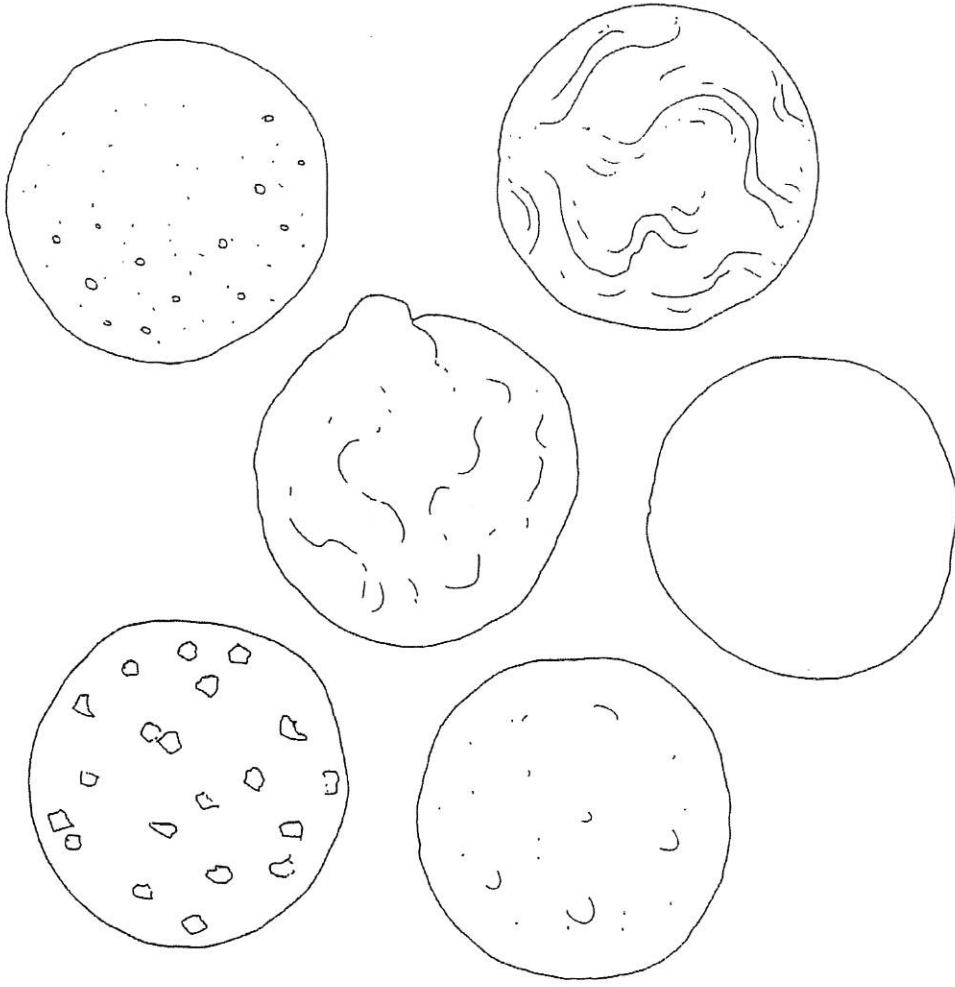
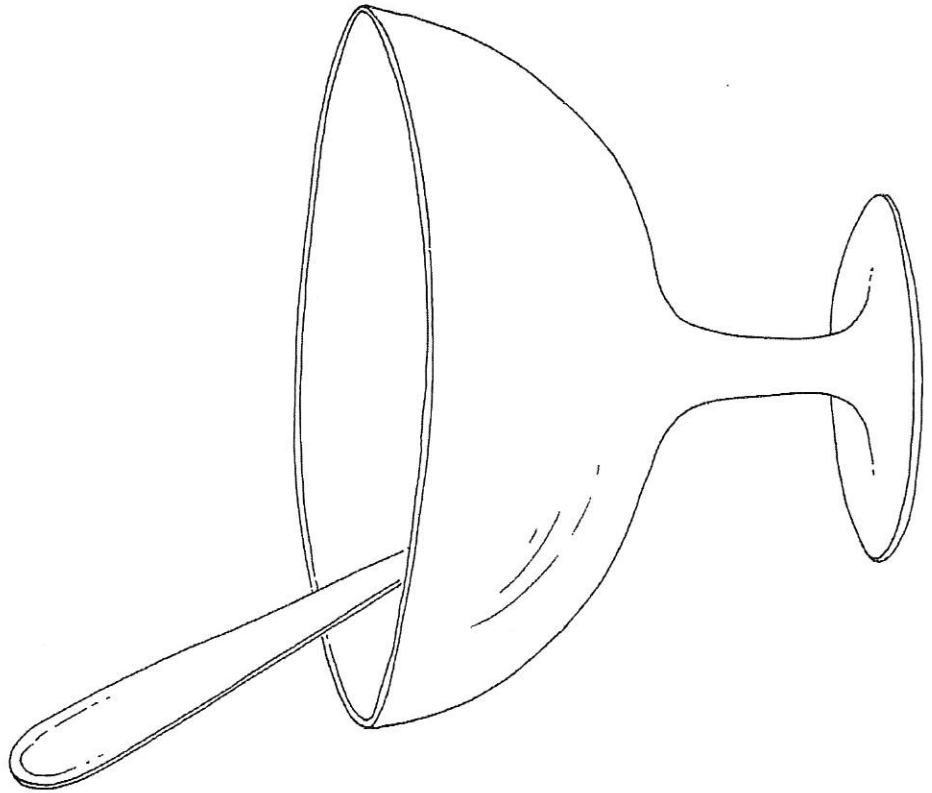

Male die Eiskugeln an.



Schneide sie aus.



Klebe sie in den Eisbecher.

6

Der Löwe ist los!

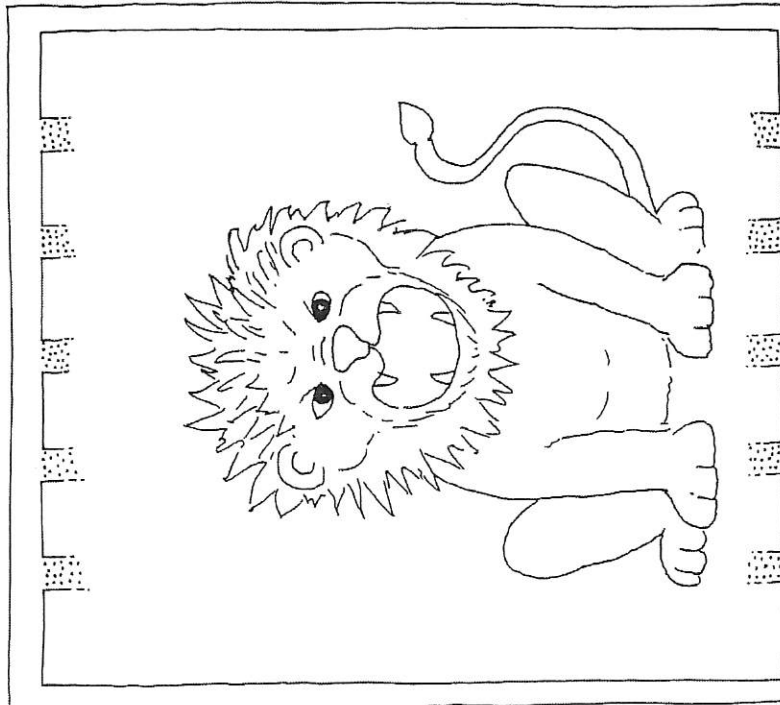

ZIRKUS

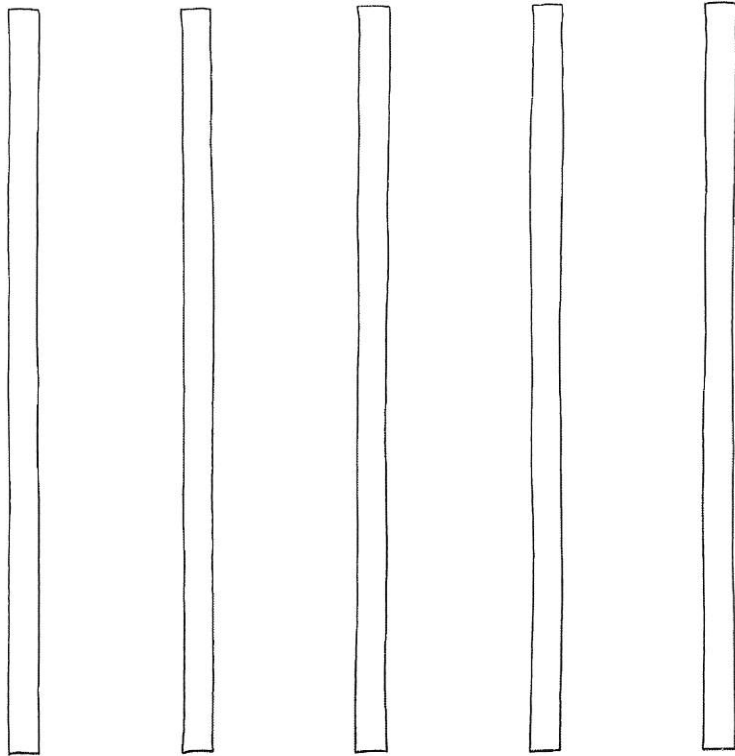
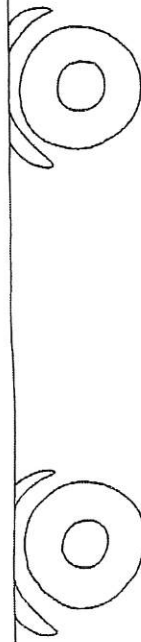

Male das große Bild an.



Schneide oben die Gitterstäbe aus.



Klebe sie auf den Käfig.

Was zieht das Mädchen an?

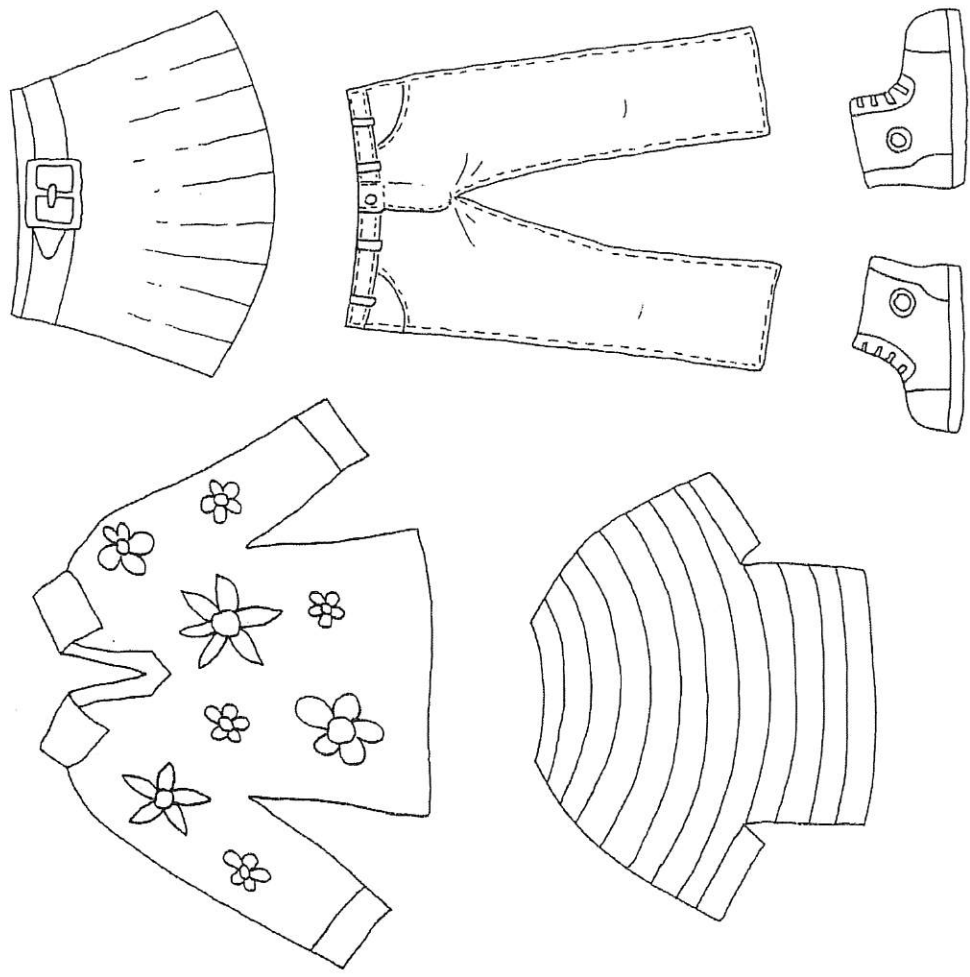
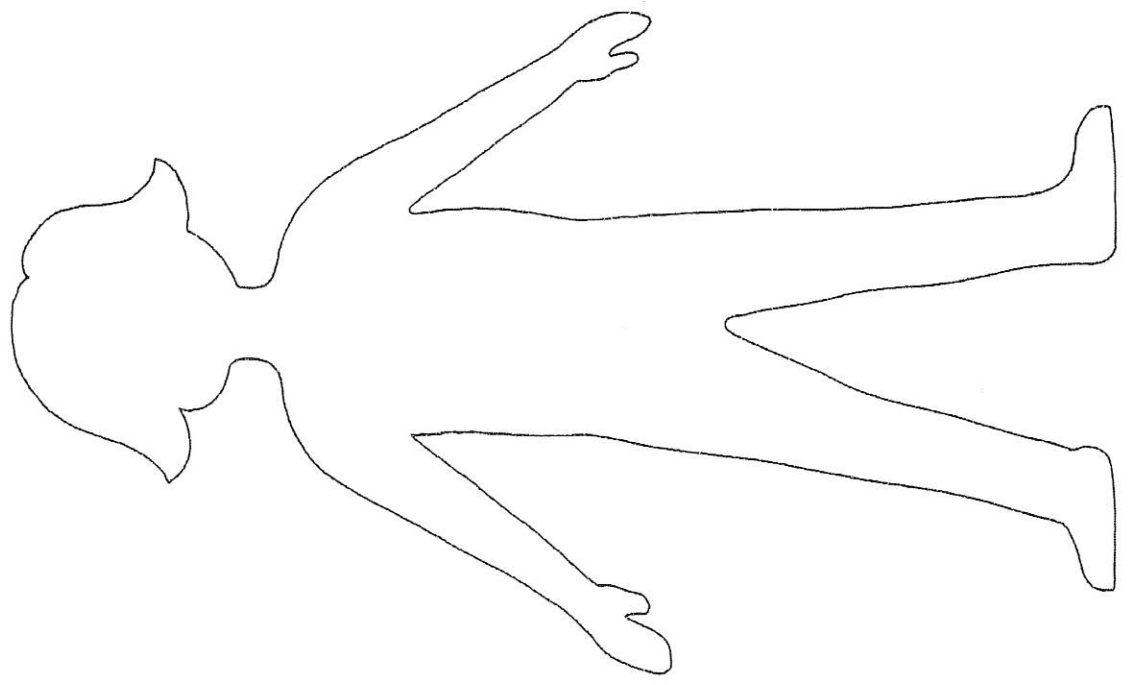

Male die Kleidung an.



Schneide die Teile aus.



Klebe sie auf das Mädchen.



Auf der Mauer, auf der Lauer...

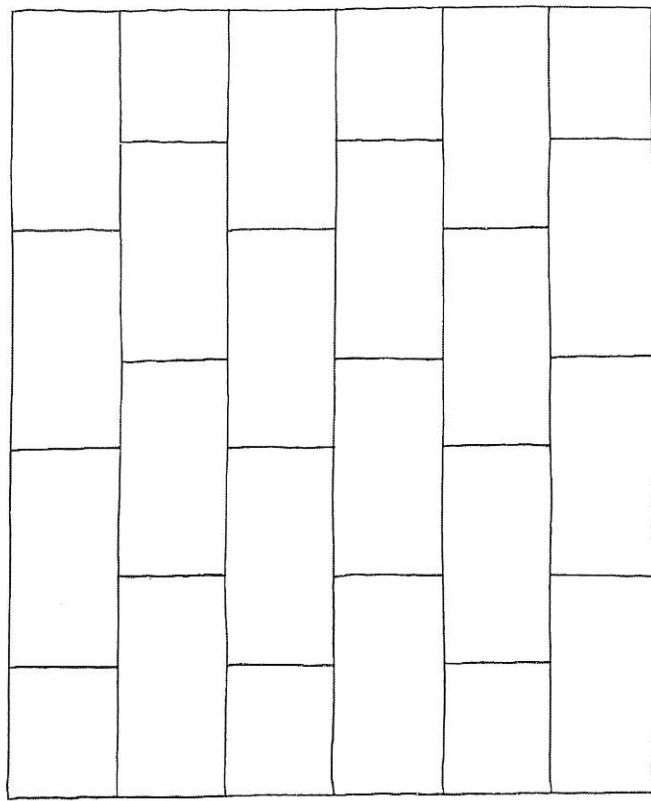
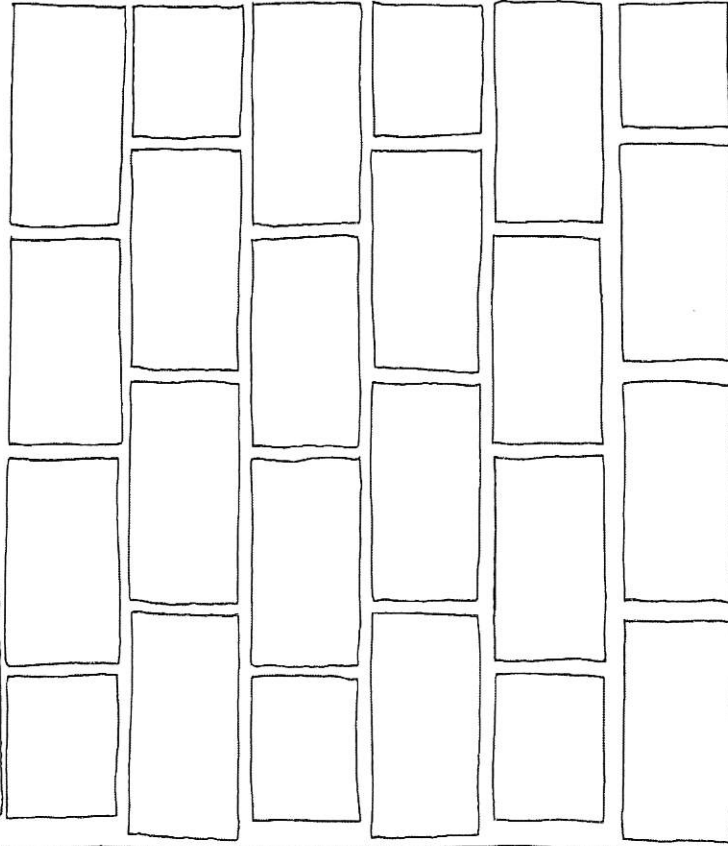
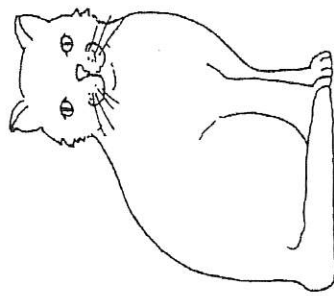

Male oben die Fläche an.



Schneide die Steine an den Linien aus.



Klebe sie passend auf die Mauer.

6

Auf dem Meer

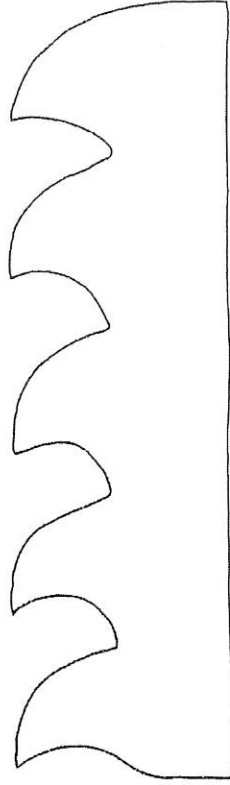
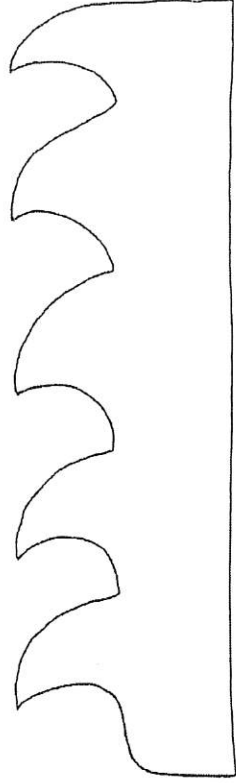
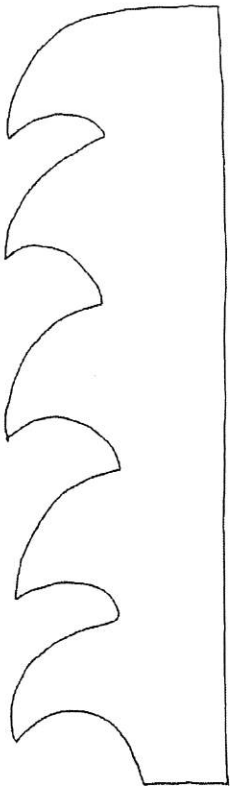
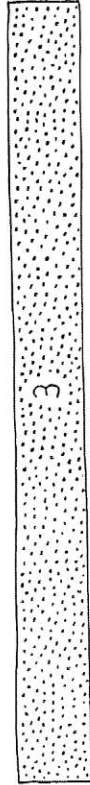
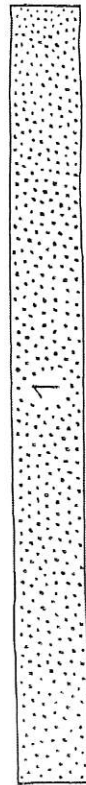
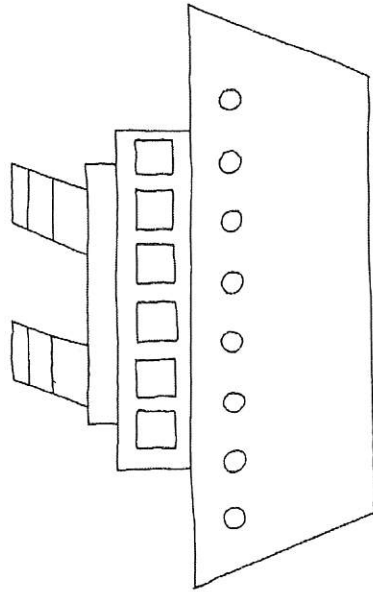

Male die Wellenstreifen an.



Schneide die Streifen aus.



Klebe die Streifen der Reihe nach auf die gepunkteten Flächen.

6

Mein Haus

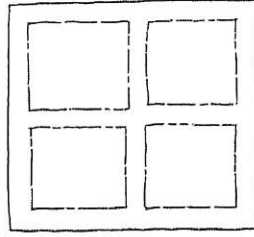
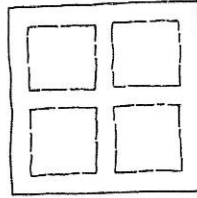
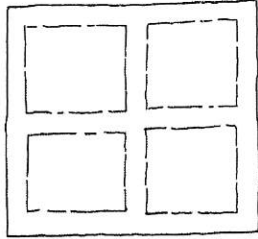
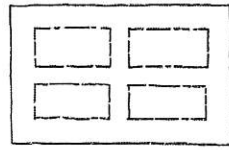
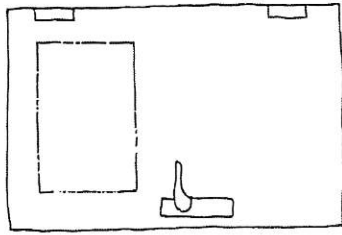
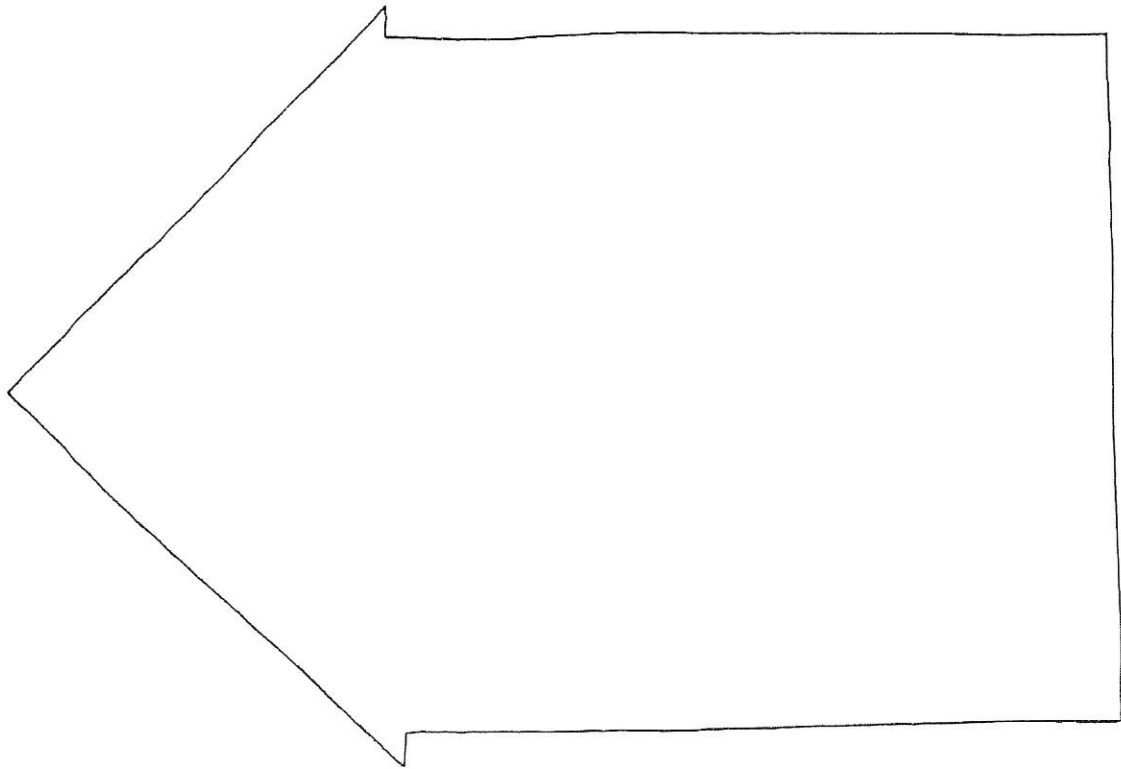

Male die Teile an.



Schneide sie aus.



Klebe Fenster, Tür und Schornstein auf.



Bunter Schmetterling

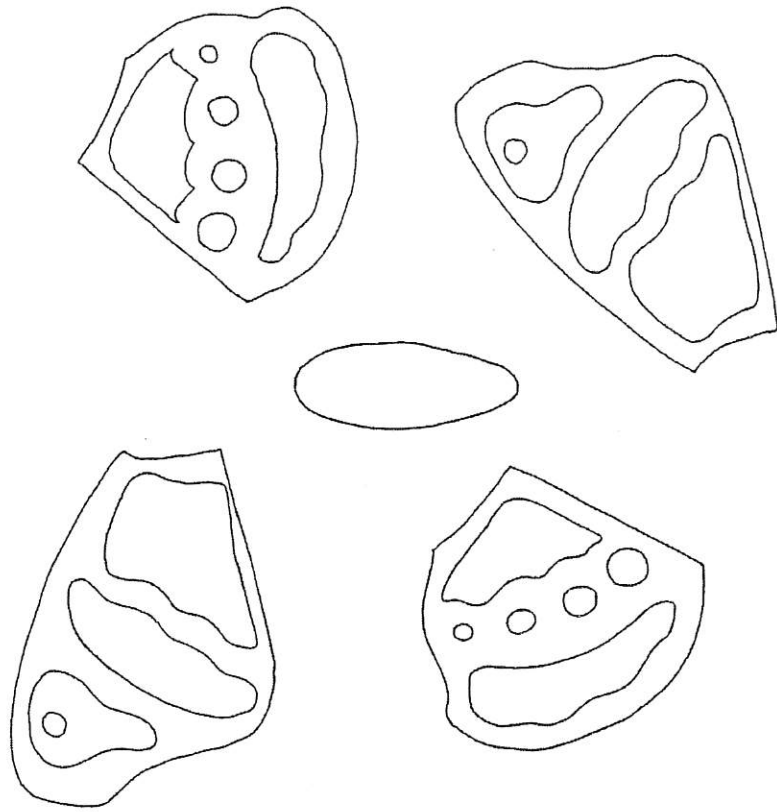
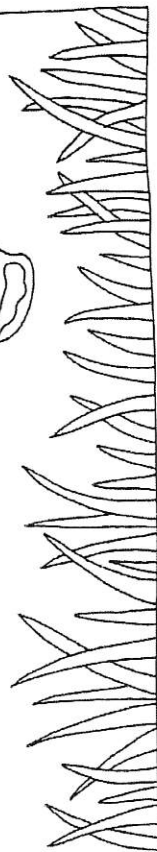
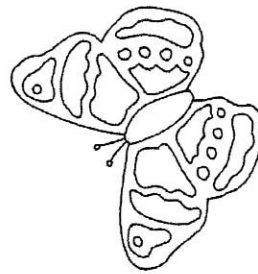
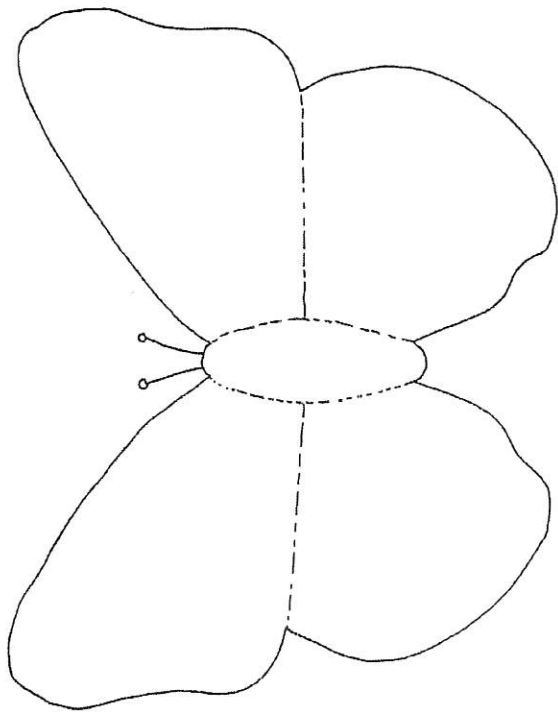

Schneide die Schmetterlingsteile aus.

Klebe die Teile in den Schmetterling.

Male das Bild an.



Sternenhimmel

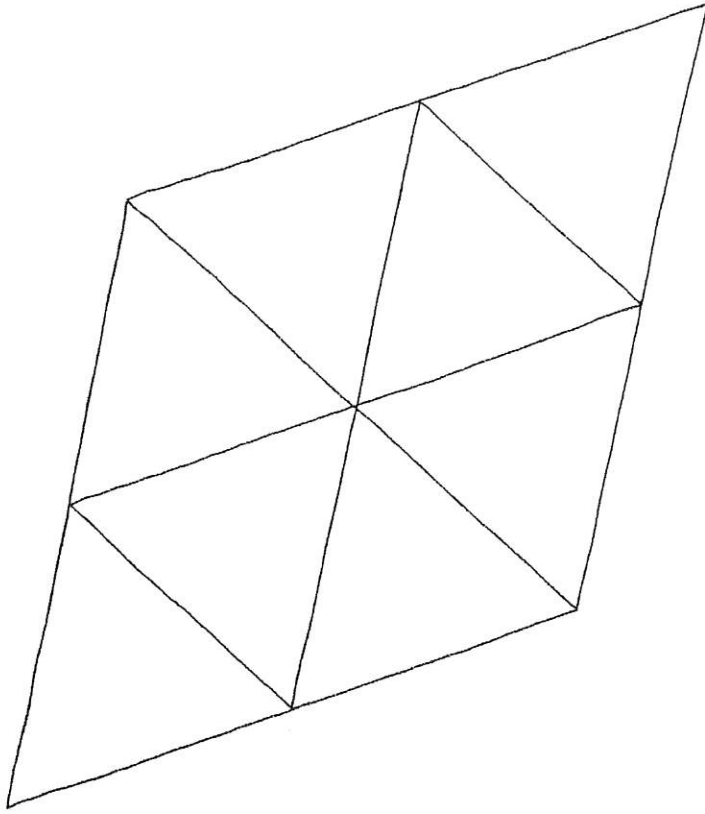
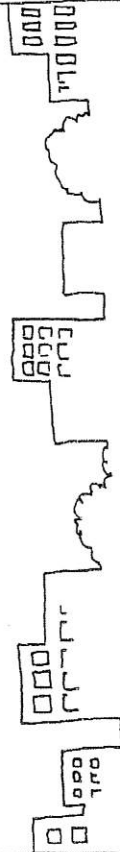
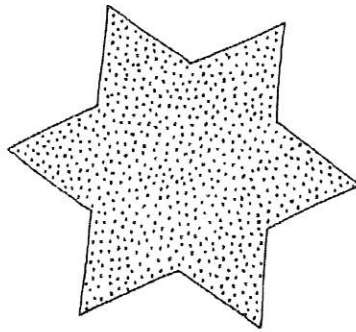
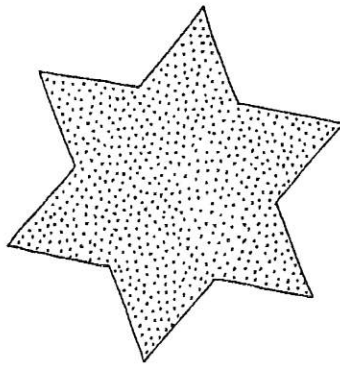
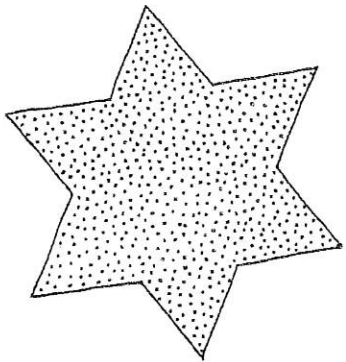
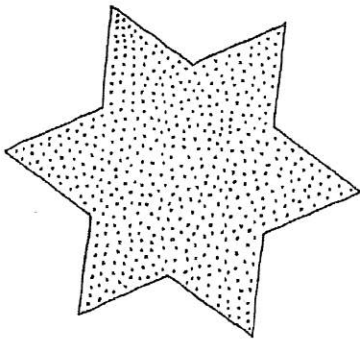

Male oben die Fläche gelb.



Schneide die Dreiecke an den Linien aus.



Klebe immer 2 Dreiecke in die Sterne.



Zick-Zack-Wald

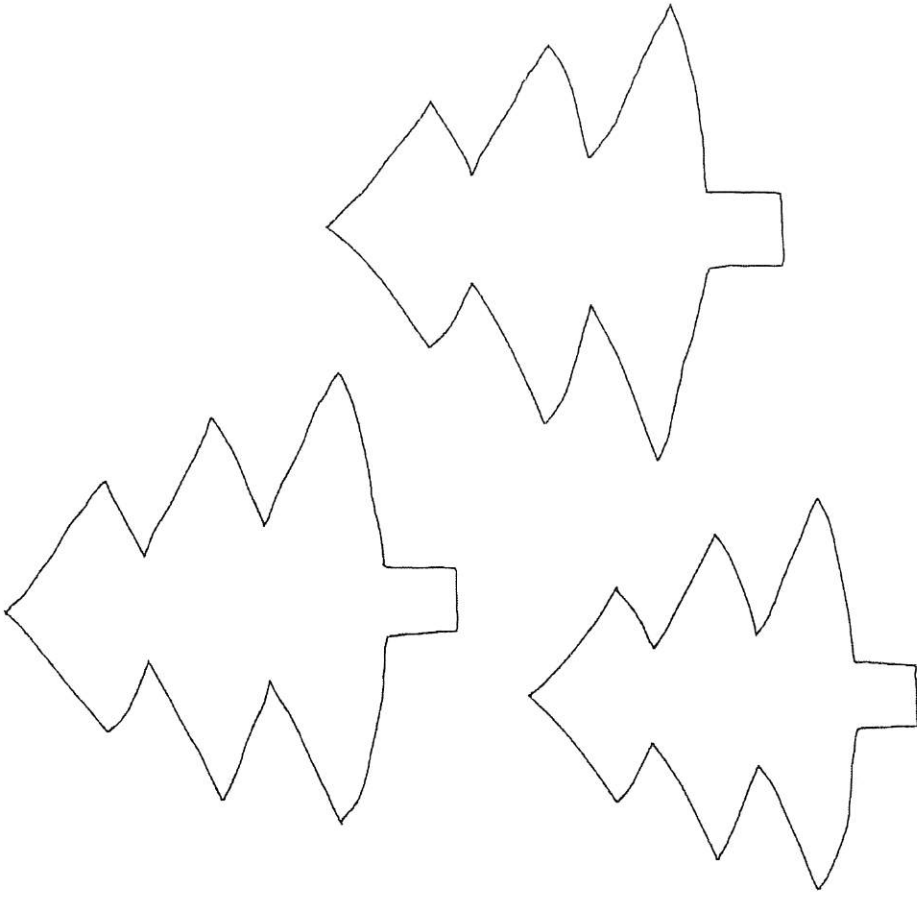
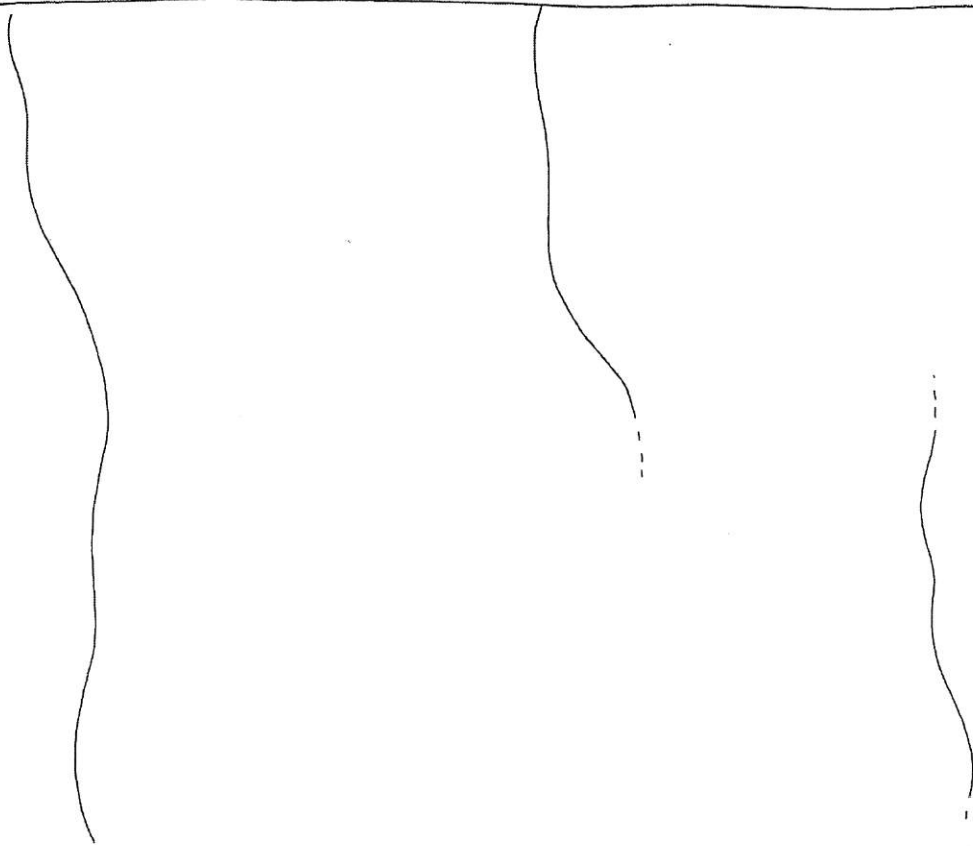

Male die Tannenbäume an.



Schneide die Bäume aus.



Klebe sie in die Landschaft.

Die Windmühle

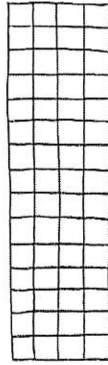
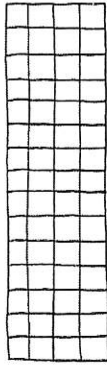
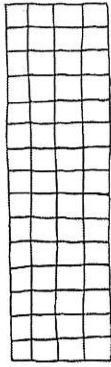
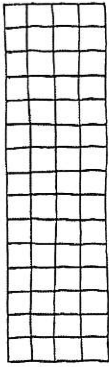
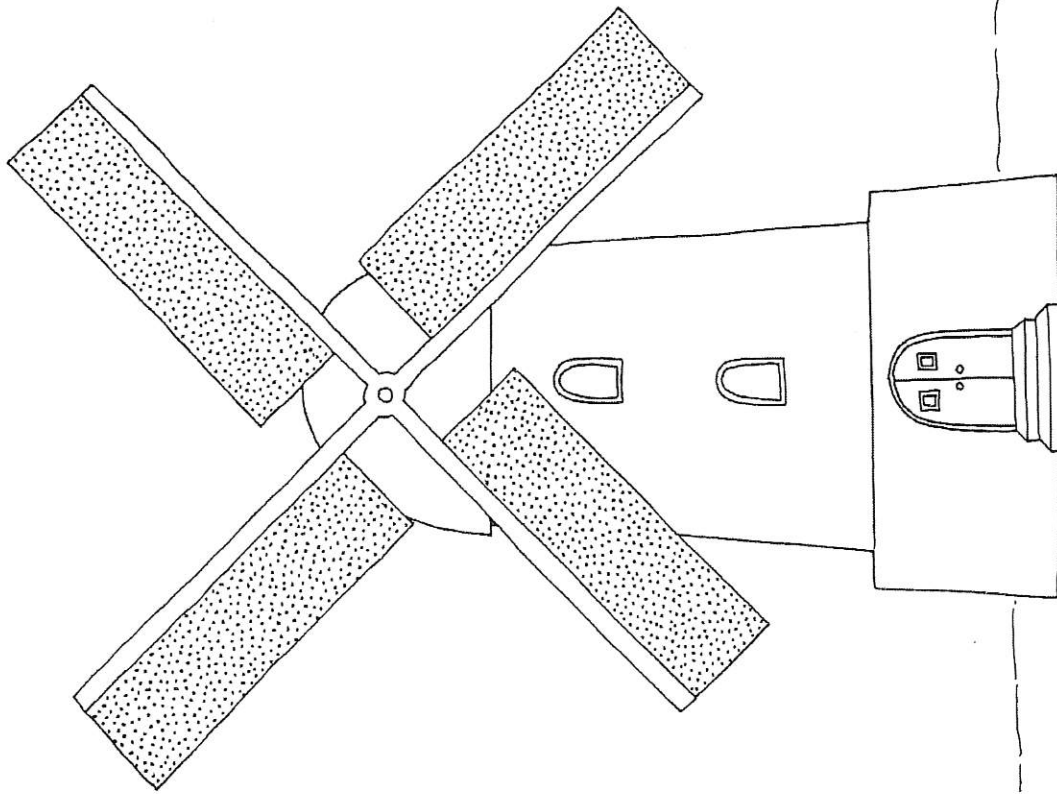

Male das große Bild an.

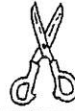

Schneide die 4 Flügel aus.



Klebe die Flügel an die Windmühle.

Die Zielscheibe

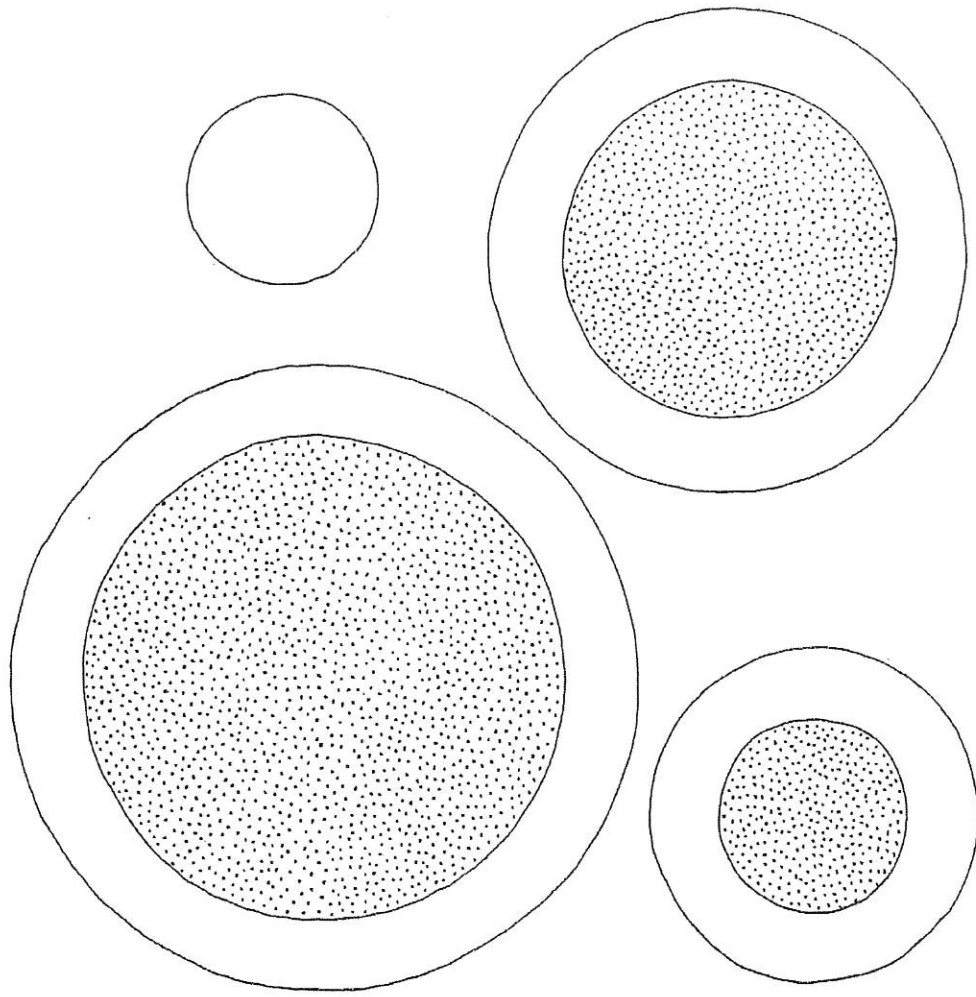
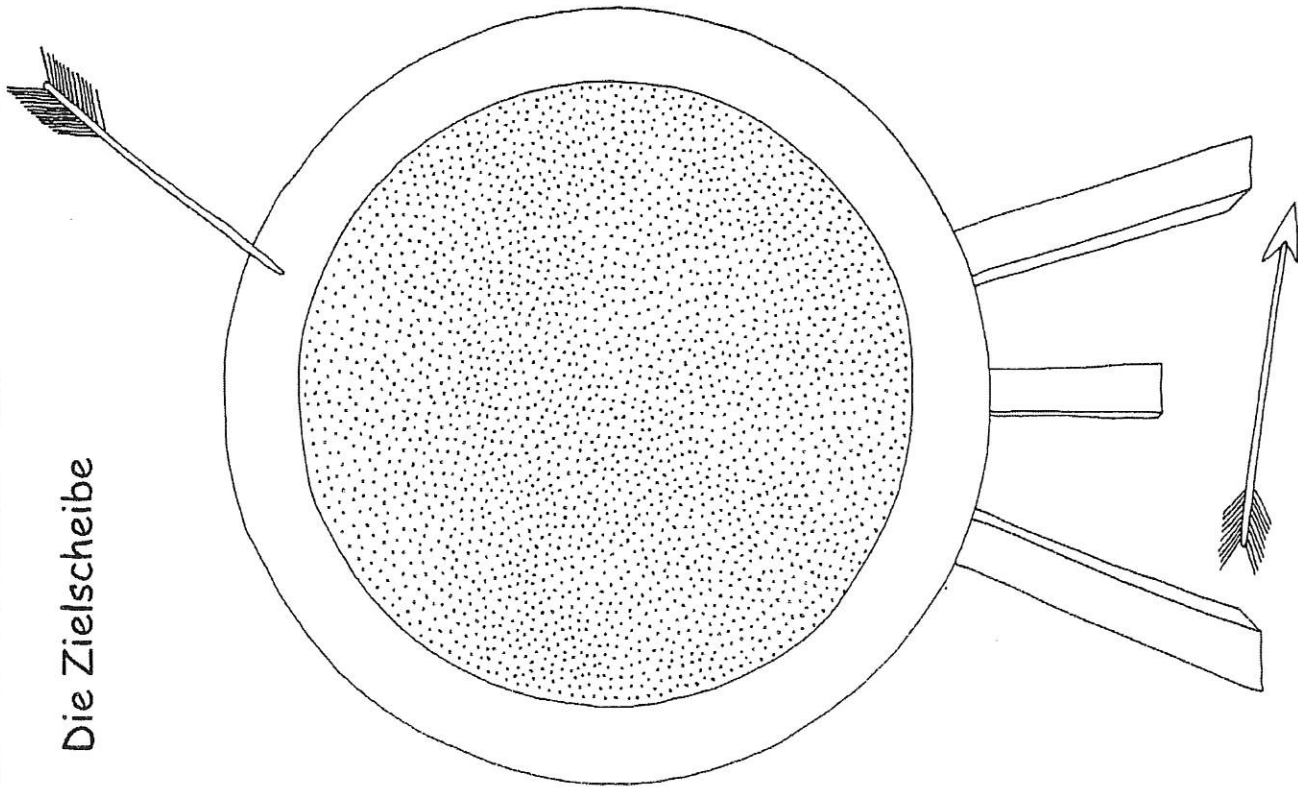

Male bei allen Kreisen die weißen Ringe an.



Schneide die Kreise aus.



Klebe die Kreise der Größe nach auf die Zielscheibe.

